

AWCL-300-6P-Audio

3 channels audio synchronized RGB Controller

User's Manual



1. Introduction :

1.1 Features :

- Support IR remote control interface.
- R , G , B bright can be adjusted individually ,and auto-saving for the setting.
- Built-in six LED dynamic programs , the dynamic of programs can be set for Fade/Jump and dynamic speed.
- Real Audio Synchronized color LED Control.
- Automatically control made switched between Audio Synchronized modes with Silent color fade mode.
- Adjustable Sensitivity for audio synchronized mode , offered Classic / Rock mode for different styles sound.
- Audio source option for Line-in or Microphone.
- The maximum output is 4A x3 channels , that is 150W/12V or 300W/24V.

1.2 Specifications



Operation Voltage	DC10V~30V °
LED Output Power	150W/12V 或 300W/24V
LED Module Type	Constant Voltage with constant current or Constant voltage with limit voltage.
Max out current	4A/channel x 3channels
Weight	250g
Size	L:110mm x W:70mm x H:23mm
Operation Temperature	0°C ~+70 °C
Storage Temperature	-20°C ~ +85 °C

2. User Guide

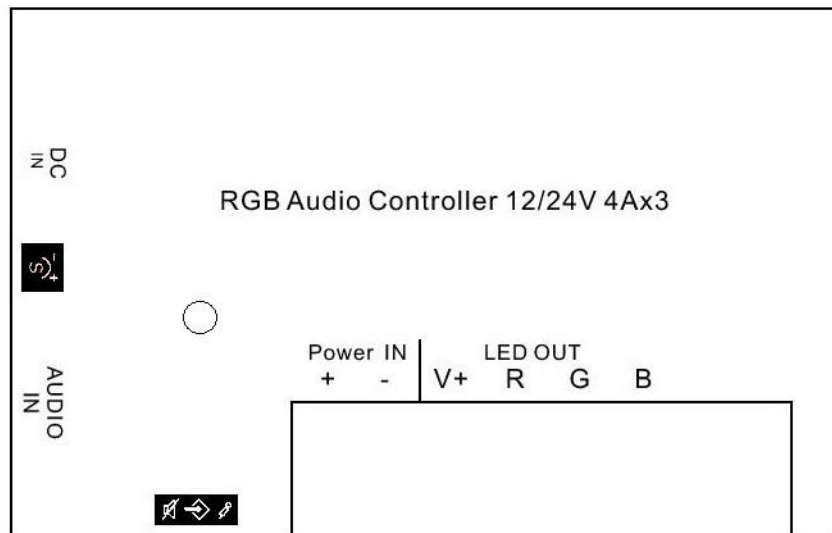
2.1 Input/Output interface



<The Upper side >

- **Power IN** : The connector of LED power supply (for DC12~30V depends on the LED module type).
- **V+** : The connector of LED power supply.
- **B** : The connector of the Blue channel (cathode of Blue LED module).
- **G** : The connector of the Green channel (cathode of Green LED module).
- **R** : The connector of the Red LED (cathode of RGD LED module).
- ○ : the microphone receiver .
- **DC IN** : DC10~30V adapter input.
-  : Sensitive control of sound source.
- **AUDIO IN** : Audio Line-In connector .
-  : Sound synchronized mode selection.

 : Silence mode.

 : Audio-In mode.



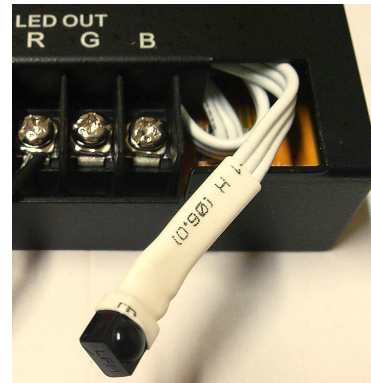

 : Microphone In mode.













- **Extension IR Receiver wire** : The 50cm long extension wire of IR Receiver could be pull out for using or storage in the case easily.

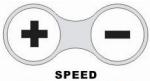





2.2 Remote Control



 Power POWER	Power On/Off
R, G, B, O, Y, I, W, P	Single color in static mode  =100% Red.  =100% Green.  =100% Blue.  Orange=100%Red+50% Green;

	 Yellow=100%Red+100%Green;  Indigo=100%Green+100%Blue;  White=100%Red+100%Green+100%Blue;  Purple=100%Red+100%Blue.)
E 	Start voice control function ; classical/rock mode switch. (See the Bottom A-2)
Speed+ /- 	P1~P6 Dynamic mode speeding or slower , total 25 degrees.※
Brightness+/- 	Adjust the Brightness for Dynamic mode and static mode , total 17 degrees.※※
Pause 	Pause/Play button when Built-in program is running.
Fade/Jump 	Switching to Fade/Jump mode while Built-In program mode.
P1~P6 Programs	Built-in color mixing 6 programs. Choice one program then set in fade or jump mode.
P1 	100%Red ->100%Red+100%Green ->100%Green ->100%Green+100%Blue ->100%Blue ->100%Red->repeat
P2 	100%Red ->100%Red+50%Green ->100%Red+100%Green ->50%Red+100%Green ->100%Green ->100%Green+50%Blue ->100%Green+100%Blue ->50%Green+100%Blue ->100%Blue ->50%Red+100%Blue ->100%Red+100%Blue ->100%Red+50%Blue ->100% Red ->Repeat
P3 	100%Red->100%Green ->100%Blue ->100%Green ->100%Red ->Repeat
P4 	100%Red ->extinguish ->100%Red+100%Green ->extinguish ->100%Green ->extinguish ->100%Green+100%Blue ->extinguish ->100%Blue ->extinguish ->100%Red+100%Blue ->extinguish ->100%Red ->extinguish ->repeat
P5 	100%Red ->100%Red+100%Green ->100%Green ->100%Green+100%Blue ->100%Red+100%Green+100%Blue ->100%Blue ->100%Red+100%Blue ->100%Red->Repeat

P6 	100%Red+100%Green ->extinguish ->100%Green+100%Blue ->extinguish ->100%Red+100%Blue ->extinguish ->repeat
R+/- 	Add/decrease red color in static mode ◦ total 17 degrees ◦ ※※
G+/- 	Add/decrease green color in static mode ◦ Total 17 degrees ◦ ※ ※
B+/- 	Add/decrease blue color in static mode ◦ Total 17 degrees ◦ ※※

※ : When using the remote controller , it will be the invalid instruction when the buzzer beeps 3 steps ◦

※ : the speeding degrees as follows : (ms)

1	2	3	4	5	6	7	8	9	10	11	12	13
0.064	0.128	0.256	0.512	0.768	1.024	1.536	2.048	3.072	4.096	5.12	7.168	8.192
14	115	16	17	18	19	20	21	22	23	24	25	
10.24	12.288	15.36	20.48	32.768	40.96	49.152	65.536	81.92	102.4	147.46	204.8	

※※ : the 17 degrees of brightness as follows : (%)

1	2	3	4	5	6	7	8	9
0	6.25	12.5	18.7	25	31.25	37.5	43.74	50
10	11	12	13	14	15	16	17	
56.25	62.5	68.75	75	81.25	87.5	93.75	100	

note:

1. R+/-/G+/-/B+/-: to mix the color you need to be in static mode.
2. P1~P6 color mixing programs : the SPEED and FADE/JUMP modes can be adjust .

2.3 Application

A. Connect AWCL-300-6P-Audio to LED lightings.

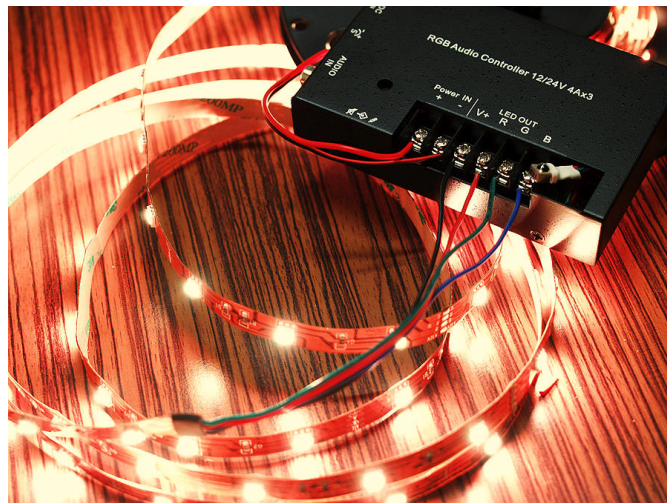
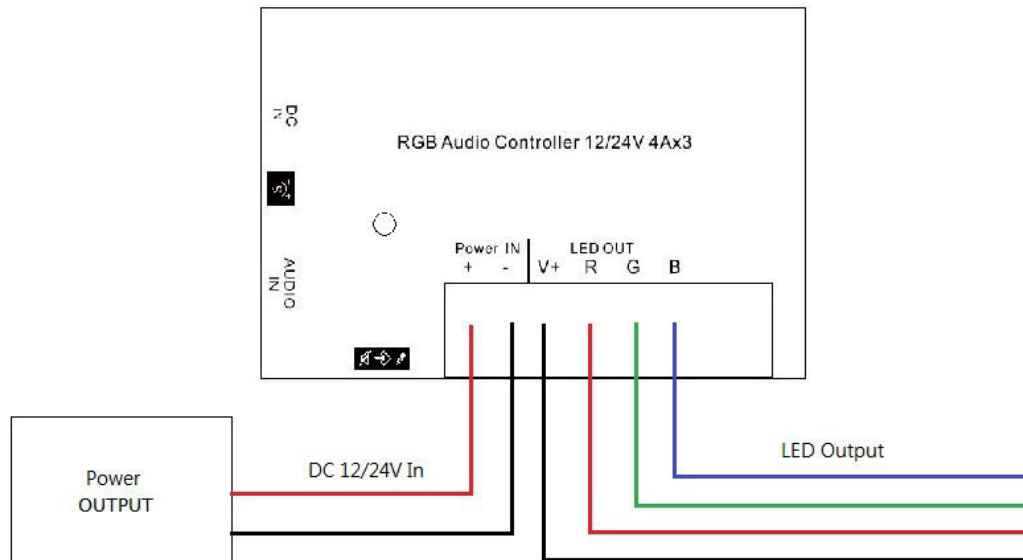

A-1. Connect AWCL-300-6P-Audio with an Audio player for sound control.

Please connect the Audio player with an Audio Amplifier and with an AWCL-300-6P-Audio by AV terminal shunt.

Therefore, it will be easy to control the audio amplifier's volume and won't influence the Line-in signal of AWCL-300-6P-Audio.

Please have below application chart for your reference:

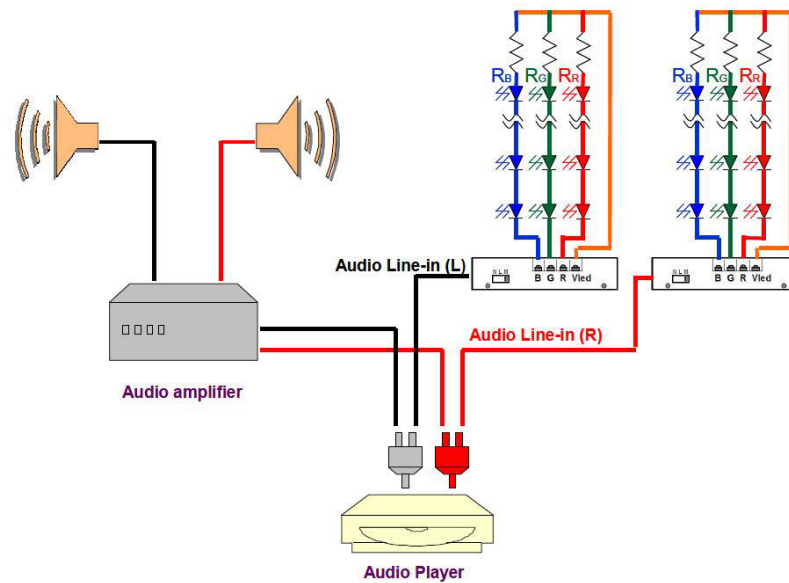

A-2. Additional function of new version AWCL-300-6P-AUDIO :

The sound control has two modes:

1: Classical mode (when press 「E」 key, beeps 1 step) : the lighting changes in fade in/fade out style and slower, fit for classical music ;

2: Rock mode (when press 「E」 key, beeps 2 steps) : the lighting changes in jump mode and faster, fit for rock or dance music.

B. Connect AWCL-300-6P Audio with a signal repeater (AWCL-300-R) for extension connecting.

With voltage drops or consumption of AWCL-300-6P-Audio is full ; connect with signal repeater AWCL-300-R by lighting strip or wires for extension connecting.

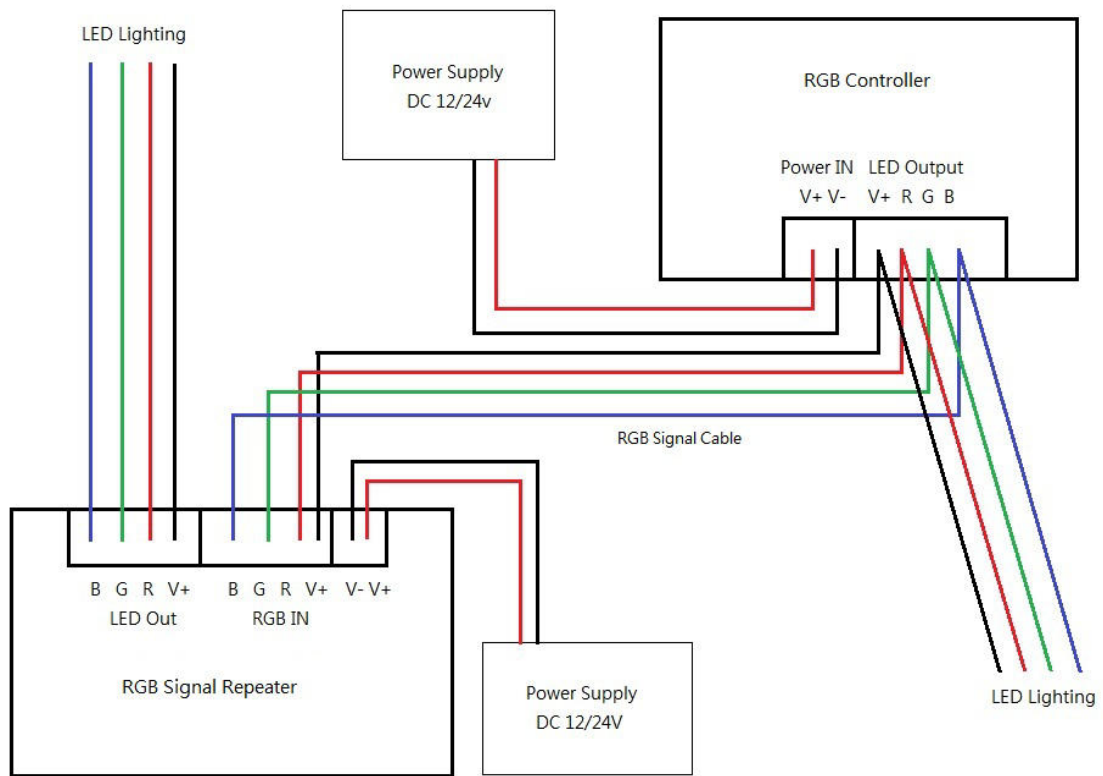

<AWCL-300-6P-Audio connects with the signal repeater by RGB wires.>

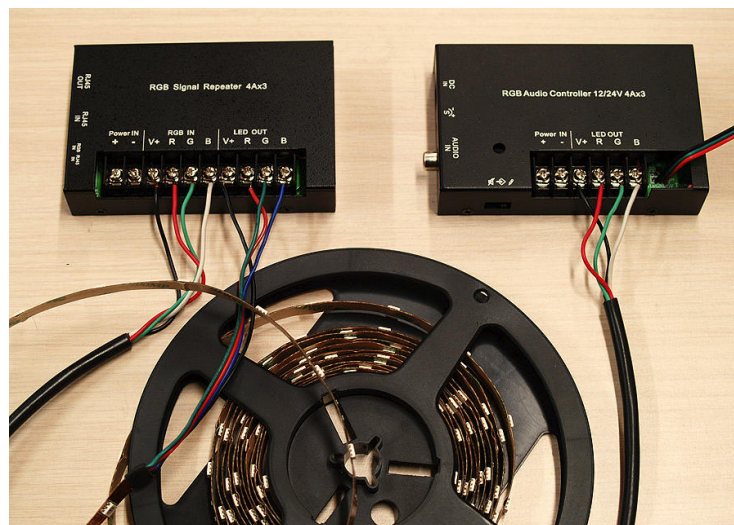

LED RGB Controller

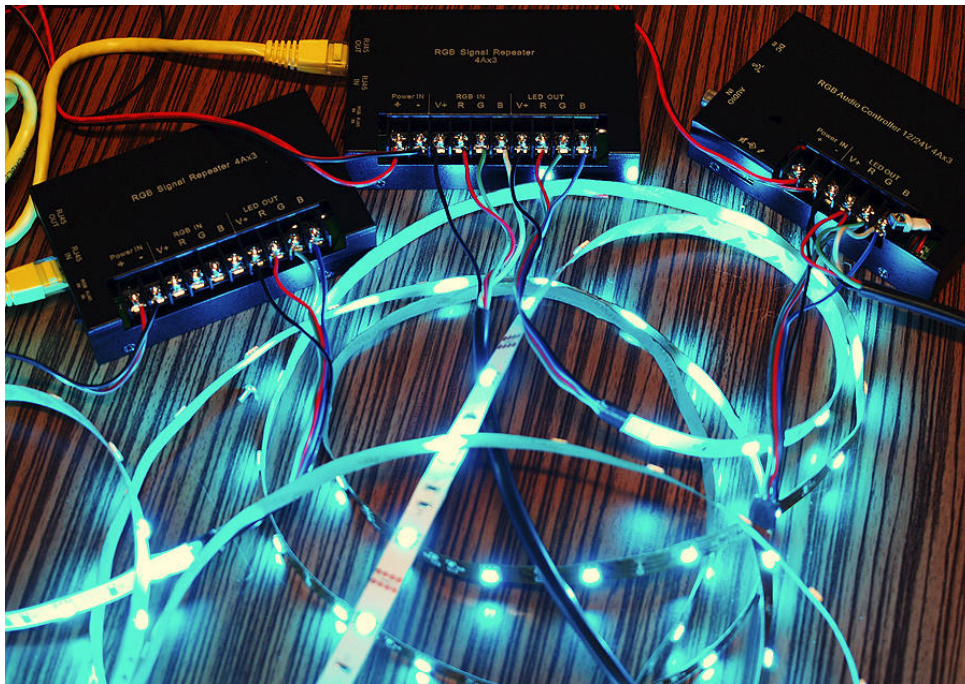
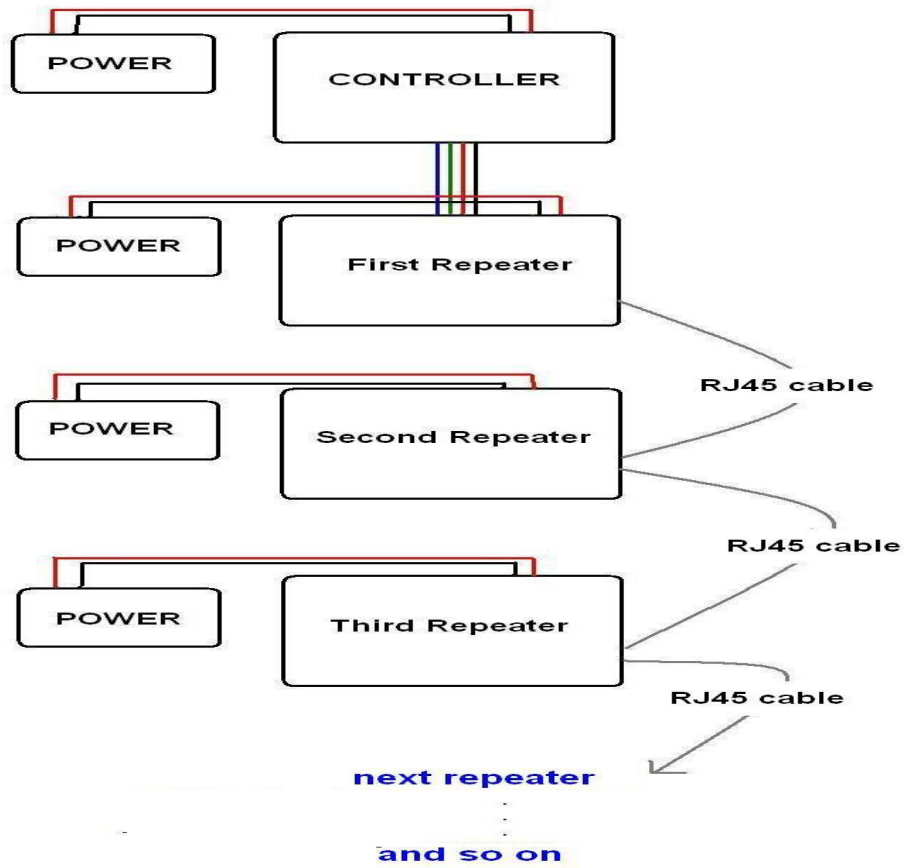

< AWCL-300-6P-Audio connect two repeaters by RGB and RJ45 signal. >

※See AWCL-300-R manual for more detail